

CAT3 RJ22 MODULAR PLUG

2 PRONG 50 μ" GOLD PLATED



009-1024/44R

ELECTRICAL

UL Applications:	250 V AC Max, AT 2 Amps
Dielectric Withstanding Voltage:	500 V AC
Insulation Resistance:	100m Ω
Termination Resistance:	20m Ω Max
	After Environmental Testing

MECHANICAL

Cable to Plug Tensile Strength:	8 lb
Durability:	200 Mating Cycles

MATERIAL

Housing:	Polycarbonate
Color:	Transparent
Contact Blade:	Copper Alloy 2 Prong
Conductor Type:	Solid/Stranded Wire
Conductor Size:	24 AWG - 26 AWG
Gold Plating:	50 u"

DESCRIPTION

CAT3, RJ22 Modular, 4P 4C,
50 μ" (Micro-Inches) Gold Plated.

FEATURES

- 50 Micro-Inches Gold Plated 2 Prong
- 24 AWG - 26 AWG Cable
- For Round Solid/Stranded CAT3 Telephone Handset Cable (4 Conductor)

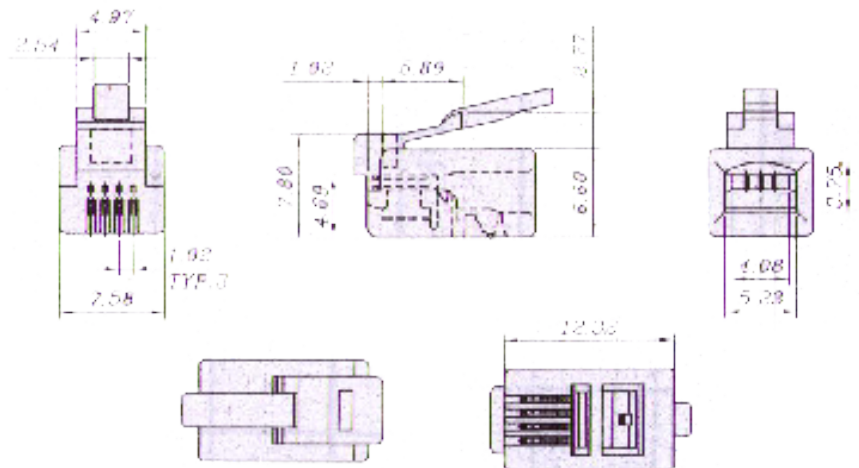
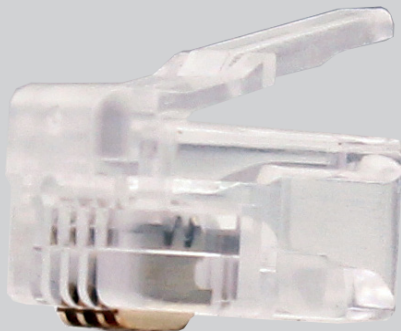

VERTICAL CABLE

951.696.7772 California
800.749.2447 Florida
845.391.8318 New York

verticalcable.com

Rev. 2/2024

Subject to change without notice.