

4 INCH J-HOOK PRE-GALVANIZED STEEL



SKU: 048-142/40

DESCRIPTION

4 Inch J-Hook

FEATURES

- Pre-Galvanized Steel
- Rust Resistant Zinc Coating
- Load Capacity 60 lbs
- For more information on load capacity, see the Load & Mechanical Capacity chart on p. 2
- Thickness: 0.05 in. (1.35 mm)

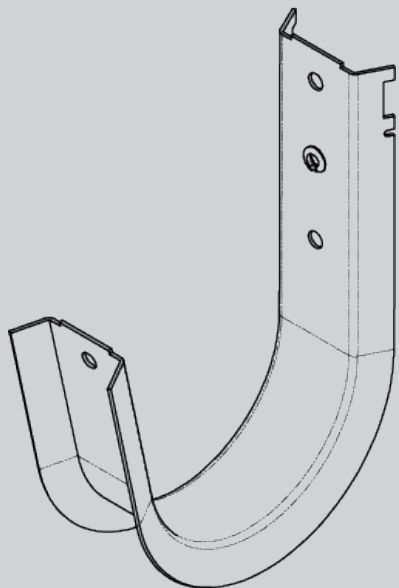

IT IS PUNCHING THREAD HOLE
FOR FITTING #1/4-20 SCREW

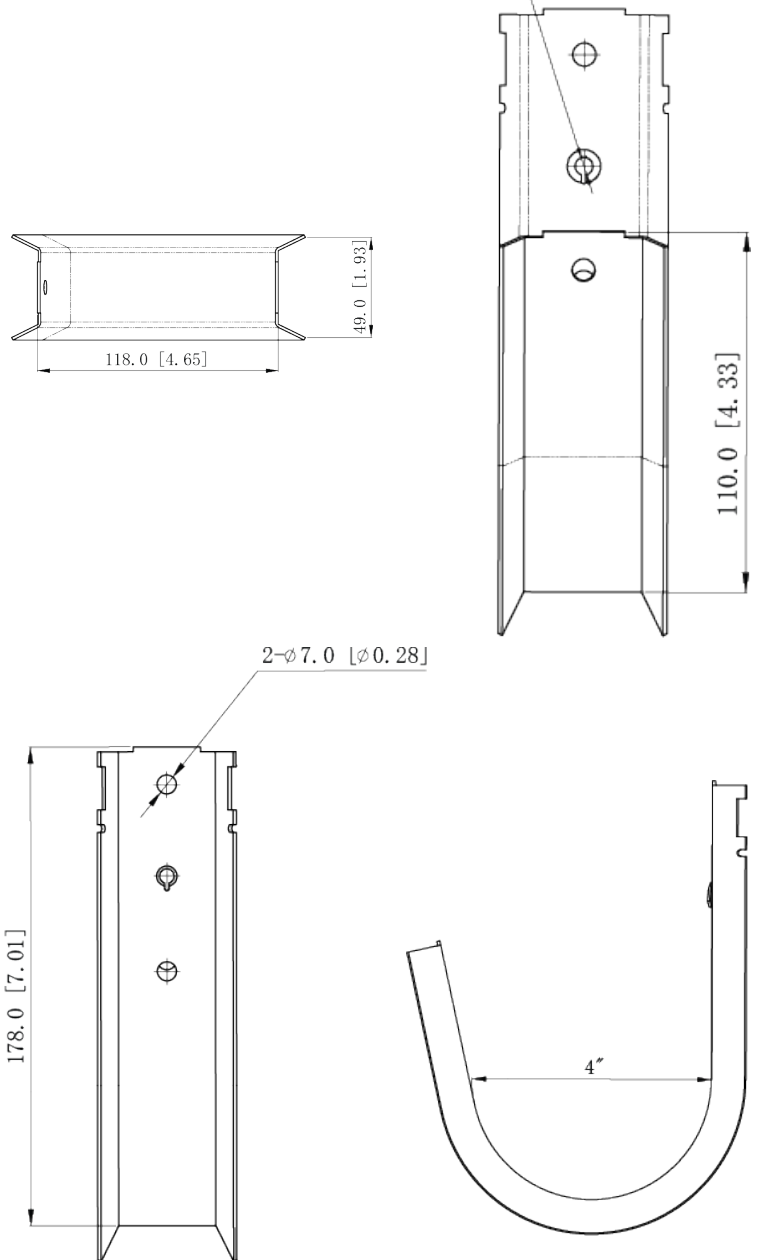

VERTICAL CABLE

951.696.7772 California
800.749.2447 Florida
845.391.8318 New York

www.verticalcable.com

Rev. 08/2022

Specs subject to change without notice.

It is the sole responsibility of the user to have the most current specs.

4 INCH J-HOOK PRE-GALVANIZED STEEL

LOAD & MECHANICAL CAPACITY:

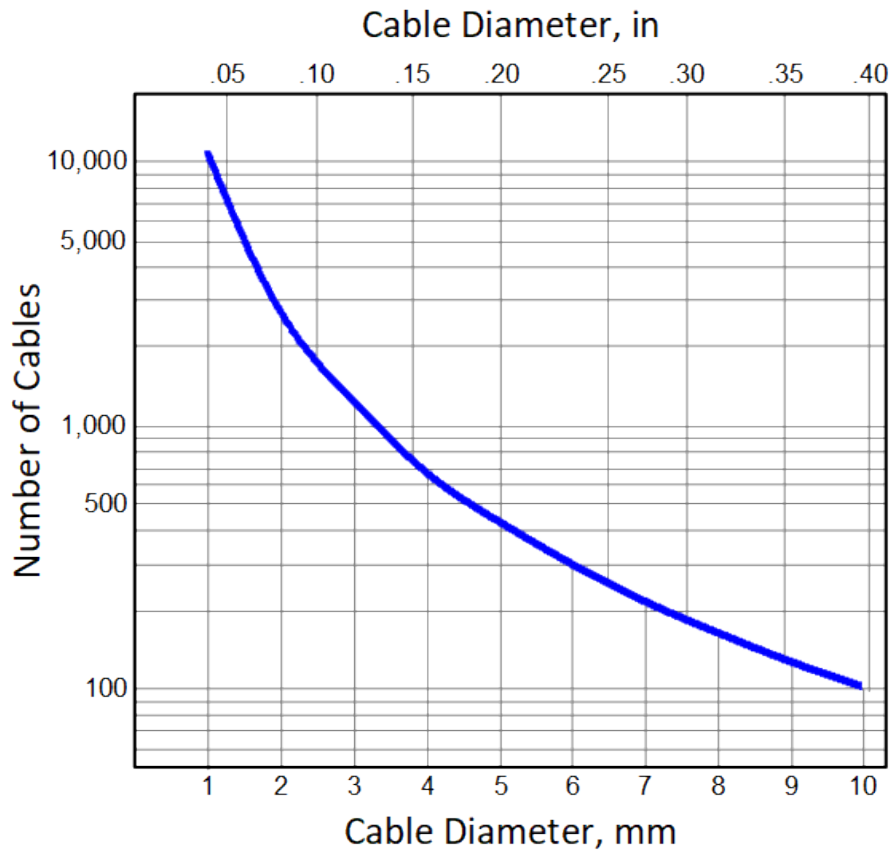

NOTE: The capacity chart provided above shows maximum possible values calculated based on the geometry parameters of the J-hooks. In real life installations, due to imperfection of cable bundles and variable paths cables take within the bundles, actual J-hook's capacity could be lower and reach 50 % of the maximum as the worst-case scenario, the uncertainty grows as the number of cables placed on the J-hook grows. Typical recommended quantity reduction should be 25 % against the values provided in the graphs.

VERTICAL CABLE

951.696.7772 California

800.749.2447 Florida

845.391.8318 New York



www.verticalcable.com

Rev. 08/2022

Subject to change without notice